

LevelSite® Supplemental Guide

Features

Model LSSM
in Typical System

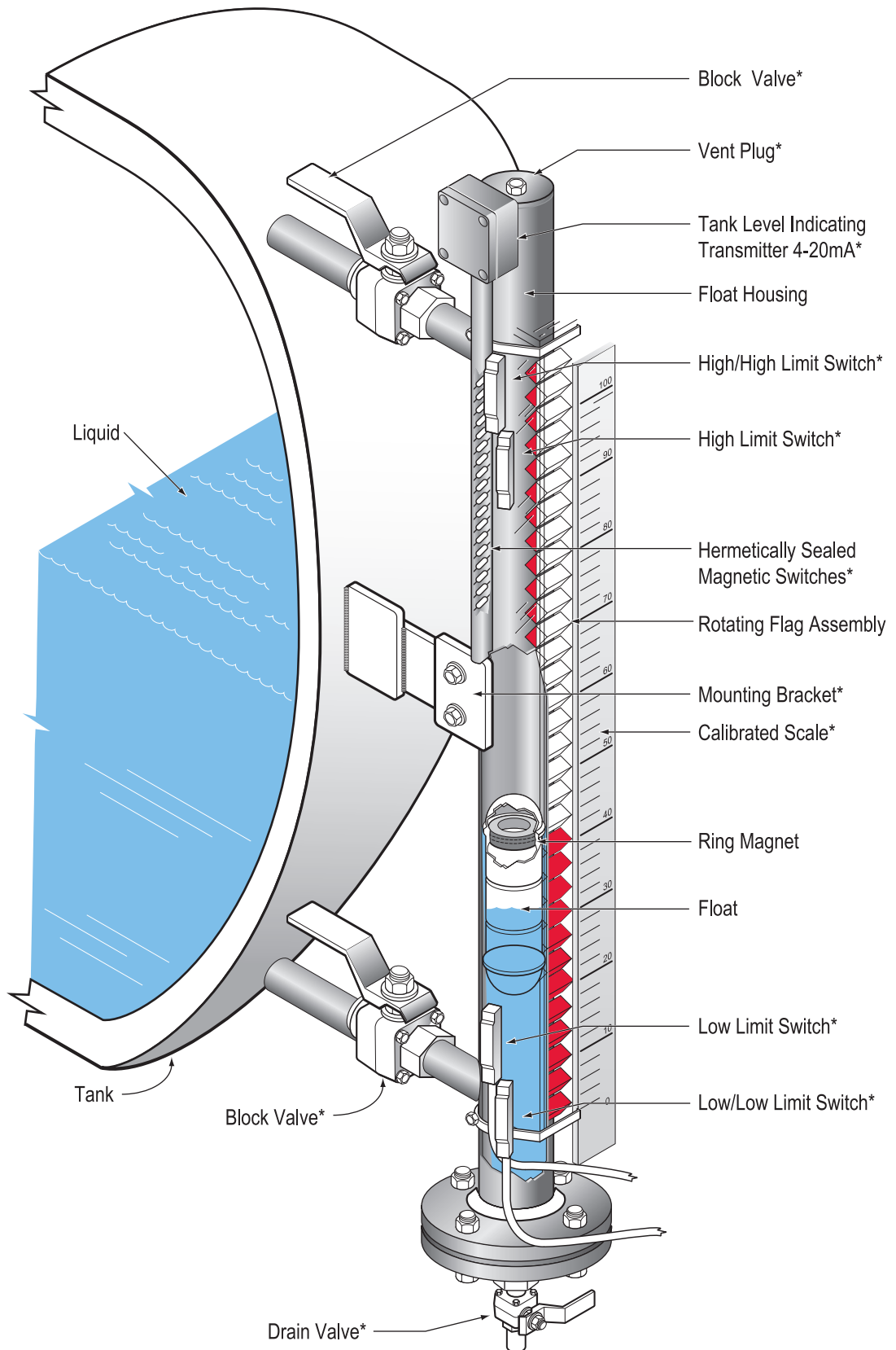

Figure 1

Operating Principle

LevelSite® is a magnetic rotary indicator. It is a reliable level measurement system for applications with operating pressures to 4500 psig (310 bar), operating temperatures to 600°F (316°C), and with liquid to a minimum specific gravity of 0.5049. LevelSite®'s

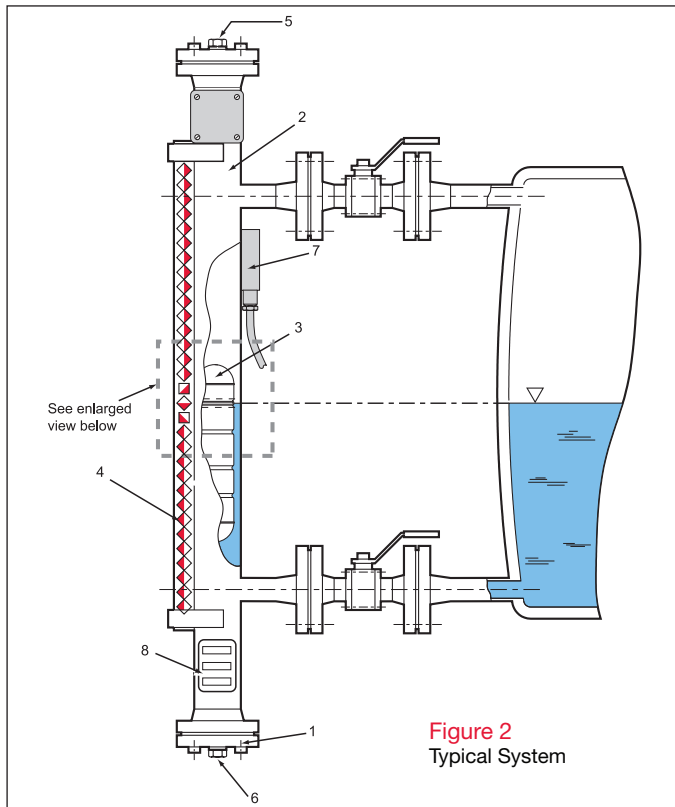

Figure 2
Typical System

visual indicators and electrical switches are isolated from the liquid; the tank remains sealed from the surrounding environment (See Figure 2). Accidental spills from sight-glass breakage are eliminated.

LevelSite® consists of 3 major components: the float housing, a magnetic float, and the rotating flag assembly. The float housing is an engineered pressure vessel which is externally mounted to the tank. The float housing is designed to handle the same temperatures and pressures found in the tank. It is fabricated from a variety of materials, depending on the application. The alloy models are usually stainless steel. Engineered plastic models use polyvinylchloride (PVC), polypropylene (PP) or polyvinylidene fluoride (PVDF). Other materials are available on request.

The float (See Figure 3), is equipped with a permanent ring magnet assembly. This assembly rides at the surface of the liquid contained within the float housing, rising and falling as the liquid in the tank rises and falls.

As the float moves up and down, a magnetic flux field maintains continuous contact with the rotating flags mounted on the outside of the float housing. Flag rotation occurs as the flux field from the permanent ring magnet acts on the magnets embedded in each flag (See Figure 4). The rotating flags below the level of the liquid in the float housing show their red side and those above show their white side.

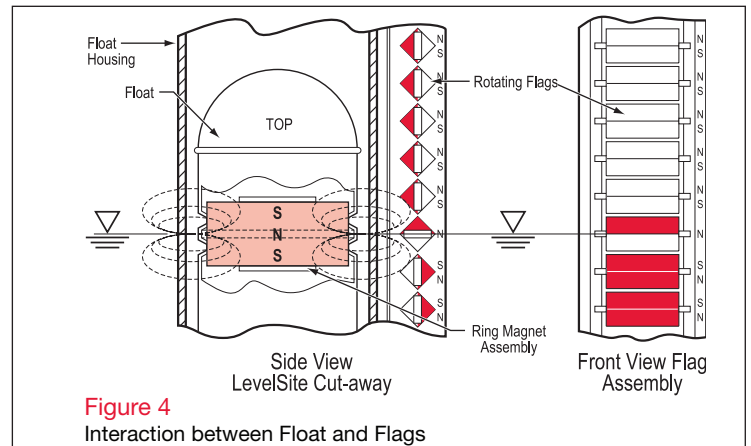

Figure 4
Interaction between Float and Flags

The special permanent ring magnet design provides a 360 degree magnetic flux field. This allows the rotating flag assembly, limit switches and continuous level sensors to be located anywhere around the float housing. Troublesome guide wires and rods, and magnetic tape on the indicating flag housing are eliminated.

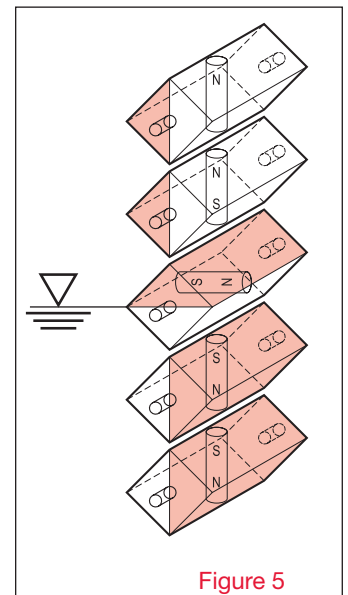

Figure 5

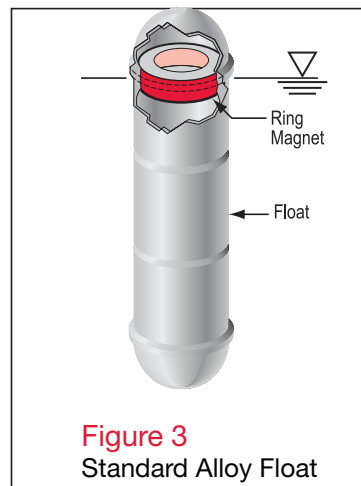
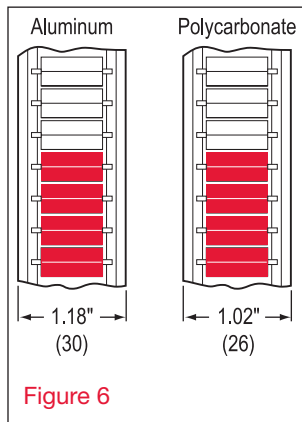

Figure 3
Standard Alloy Float

Visual Indication

LevelSite®'s rotating flag assembly provides maximum visibility and has a resolution of 1/2" (12.7 mm). Rotating flags have a square profile with embedded permanent magnets. The flux field generated by the ring magnet in the float interacts with the flag magnets causing them to rotate as the float moves up and down inside the housing. After the flags rotate to the new position, the embedded magnets lock the flags in place, making the flags less sensitive to vibration (See Figures 4 and 5).



LevelSite®'s rotating flags are mounted in a housing fabricated of extruded aluminum or polycarbonate. The assembly is attached to the outside of the float housing with stainless steel clamps. The ends are sealed against dust and moisture. Since the flags are never in contact with the liquid, they never need to be cleaned and they can't discolor. If the rotating flag assembly is accidentally crushed, there is no danger of a liquid spill. The rotating flag assembly is available in aluminum or polycarbonate and measures 1.18" (30 mm) and 1.02" (26 mm) wide, respectively (See Figure 6).

Aluminum flags are offered in an anodized finish of red and silver or painted in red and white. Anodized flags are suitable for service up to 400°F (200°C); painted versions can be subjected to 600°F (316°C). A glass pane protects the flags. The housing is extruded, black anodized aluminum.

Polycarbonate flag housings are clear and impact-resistant. They offer 180° visibility of the flags; level can be seen from front and sides (See Figure 5). Housing and flags can withstand temperatures to 250°F (121°C). Standard flag colors are red and white.

System Specifications

LevelSite®'s are designed according to the unique requirements of each application. Based on information provided by the user regarding operating temperature, pressure, and "normal" specific gravity of the liquid, a float is selected appropriate to the application. Maximum and minimum conditions are evaluated to ensure that the LevelSite® will function not only at the normal condition, but at each extreme. Maximum temperature and pressure are parameters used to design the pressure vessel (float housing).

Barksdale applies their own standards in the design of LevelSite®'s. Figures 8 and 9 can be used as a guide in selecting the ANSI class flanges and materials appropriate for your temperature and pressure conditions.

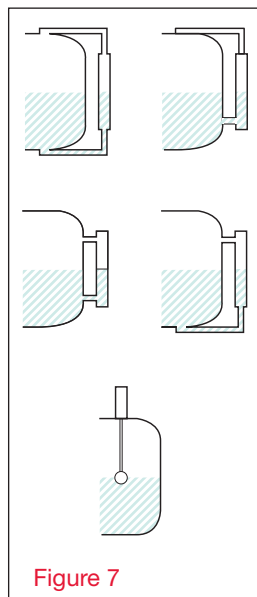

Figure 7

Configuration

Barksdale's LevelSite® is a unique system that can be custom designed for many types of applications, from a stand-alone, no-power-required level indicator to a fully-integrated electronic component within a process control system. It can be supplied with process connections located for any of the four standard patterns: top/bottom, top/side, side/side, or side/bottom (See Figure 7). For applications where tank-side mounting of the LevelSite is not practical or desired, top mounted versions are available. Liquid interface configurations require three process connections (See Figure 7).

Quality

Quality and dependability are built into every Barksdale LevelSite. As a registered ISO 9001 manufacturer, Barksdale meets the most demanding international standards. LevelSite® can be certified to ASME, ANSI, DIN, BSP and other codes.

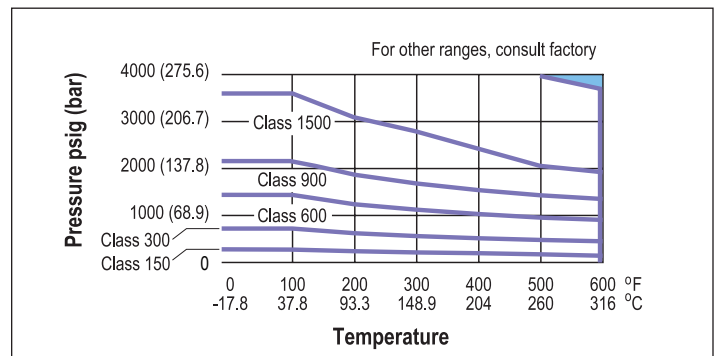

Material

Pressure/temperature performance parameters for LevelSite housing constructed of 316 stainless steel are specified in the chart. Please consult the factory with pressures/temperatures requiring other alloys.

Figure 8

Alloy - maximum operating pressure vs. temperature for ANSI classification.

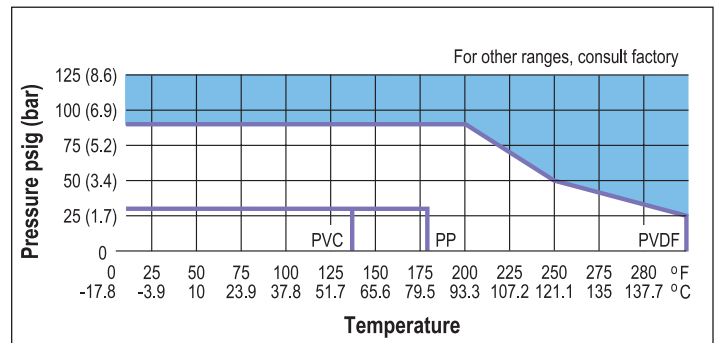

Material

Pressure/temperature performance parameters for LevelSite housing constructed of PVC, PP or PVDF are specified in the chart. Please consult the factory with pressures/temperatures requiring other materials.

Figure 9

Engineered plastic - maximum operating pressure vs. temperature

General Installation

LevelSite®s are measuring instruments and must be properly treated as such. Make sure that all parts are available and the connecting flanges on the tank correspond to those on the indicator. The float and limit switches (if applicable) are enclosed in a separate box. Remove the bottom connection flange (1) of the float chamber and insert the float with the top uppermost. Replace the bottom flange with the gasket, fixing it to the chamber by tightening all the bolts securely. The LevelSite® must be raised slowly and carefully so that the float is not damaged by severe impact.

Mechanical Installation

It is essential to ensure that the flanges on the tank are accurately aligned with the flanges on the LevelSite®. Non-alignment of the flanges causes distortion of the float chamber (2) with the possibility that the float (3) will stick. The LevelSite® must always be mounted vertically. Before commissioning, the flags in the flag assembly (4) must be aligned by means of a magnet so that they all show the color white (polycarbonate) or silver (aluminum). NOTE: It is essential for all flange bolts, the vent-plug (5) and the drain-plug (6) to be fully tightened.

Electrical Installation

The electrical limit switches (7) may be attached at any point in the range on the indicator bar by means of a stainless steel clip. Ensure that the stainless steel clips are installed under the flag assembly. The maximum electrical switching capacity is specified on the nameplate of the limit switch (7) and must not be exceeded. IMPORTANT: The operation of the LevelSite® is based on the magnetic field principle. Ferrous strips, clamps, or screws must not be used.

Commissioning

LevelSite®s are always application specific. The most important technical data such as pressure and temperature limits are specified accurately on the nameplate (8). However, the sales drawing for the model number referenced on the nameplate is specific and detailed to the application and is the governing specification document. Before commissioning, a check must be made to ensure that the technical data shown on the nameplate corresponds exactly with the plant requirements. NOTE: Test pressure and test temperature of the plant must NOT exceed the specifications.

Tank Level Indicator (TLI) Installation

The transmitter is installed on the side of the LevelSite® housing, utilizing stainless steel clips, with the transmitter's probe along the housing. The transmitter may be used in addition to a visual indicator (rotating flag assembly) to provide electronic monitoring of fluid level. If the transmitter is used with a flag assembly, it may be necessary to slide the transmitter's clamps under the flag assembly. The transmitter is supplied with a mark on its probe. This mark must line-up with the centerline of the process connector on the LevelSite®. If the transmitter's probe spans the entire measuring range ->

(center-to-center of the process connections), the probe will be marked to show the measuring range. Electrical Connections: Ground the transmitter's housing if necessary. The cable length may be up to 3 miles. The transmitter is designed to be maintenance-free and is not field-serviceable. If the unit is not operating properly, replace the entire unit. For more information, refer back to "Tank Level Indicating Transmitter".

